

Article number: 201091706

Description: E+G Lock pin
GN 114.2-16-40

Measures

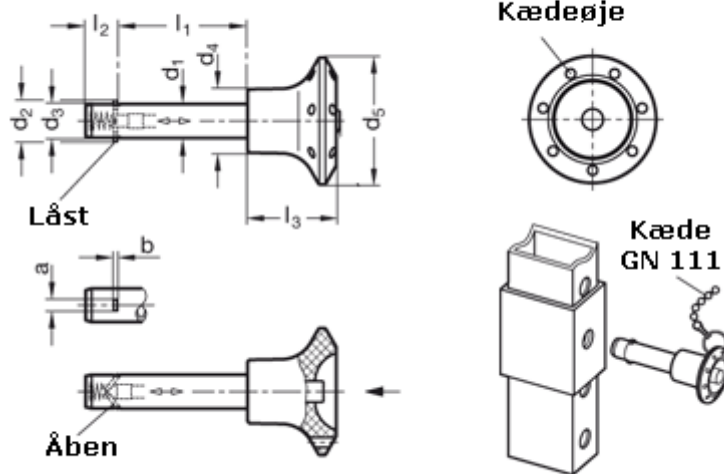

a	= 4,8	l1 = 40
b	= 1,2	l2 = 14,2
Clamping force (kN)	= 110	l3 = 32
d1	= 16	
d2	= 19,9	
d3	= 15,9	
d4	= 22	
d5	= 40	